

# 5.0 x 3.0 x 0.5 (mm) ISM 868 MHz Ceramic Chip Antenna (AA701)

## Engineering Specification

### 1. Product Number

H 2 U 6 4 U 1 H 2 B 0 2 0 0

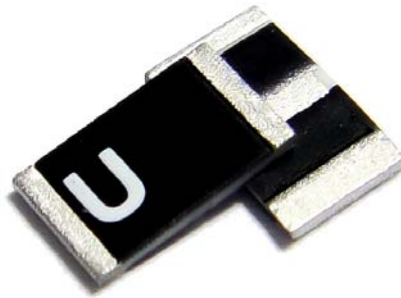

### 2. Features

- \*Stable and reliable in performances
- \*Low profile, compact size
- \*RoHS compliance
- \*SMT processes compatible

### 3. Applications

- \*Short Range Devices (SRD)
- \*IoT applications
- \*Alarm system

### 4. Description

Unictron's AA701 ceramic chip antenna is designed for ISM 868MHz band applications, covering frequencies 863~870 MHz. Fabricated with proprietary design and processes, AA701 shows excellent performance and is fully compatible with SMT processes which can decrease the assembly cost and improve device's quality and consistency.

2016-12-28

Document  
Control Center



詠業科技股份有限公司  
Unictron Technologies Corporation  
Website: www.unictron.com

THIS DRAWINGS AND SPECIFICATIONS ARE THE PROPERTY OF UNICTRON TECHNOLOGIES CORPORATION AND SHALL NOT BE REPRODUCED OR USED AS THE BASIS FOR THE MANUFACTURE OR SALE OF APPARATUS OR DEVICES WITHOUT PERMISSION

Prepared by : Xenia

Designed by : Allen

Checked by : Mike

Approved by : Herbert

TITLE : 5.0 x 3.0 x 0.5 (mm) ISM 868MHz Ceramic Chip Antenna (AA701) Engineering Specification

DOCUMENT NO.

H2U64U1H2B0200

REV.

I

## 5. Layout Guide & Electrical Specifications

### 5-1. Layout Guide (unit : mm)

Solder Land Pattern:

The solder land pattern (gold marking areas) is shown below. Recommendation on matching circuit will be provided according to customer's installation conditions.

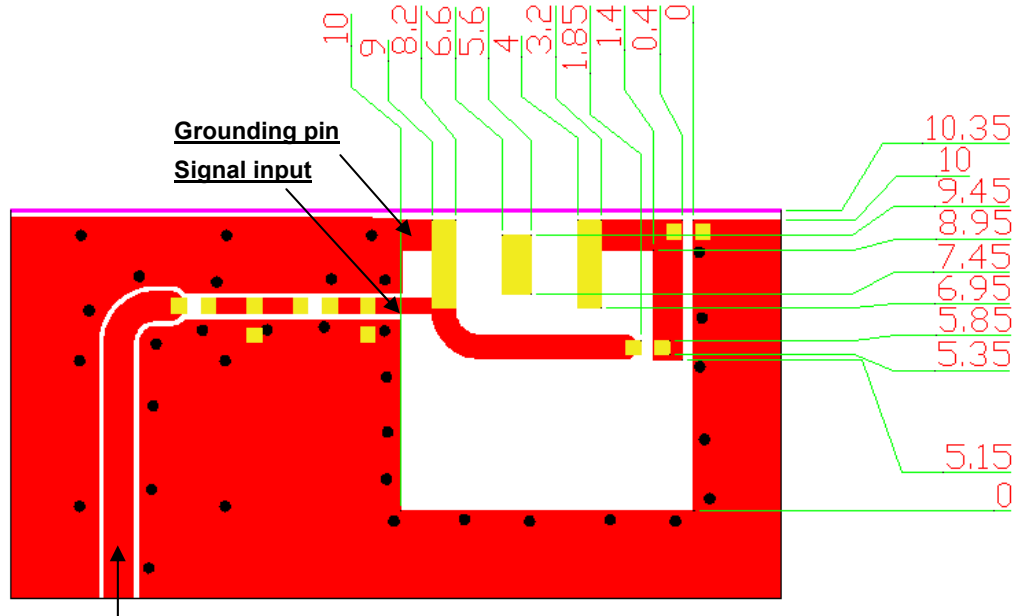

Transmission Line with 50Ω Impedance Characteristic Top View

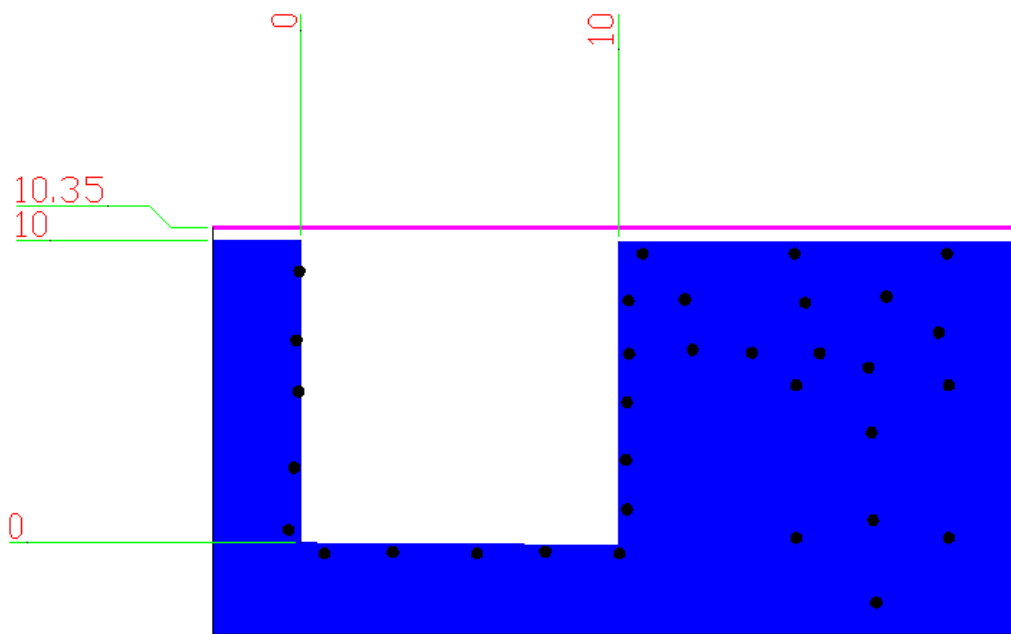

Bottom View

Unictron  
Technologies Corp.  
2016-12-28  
Document  
Control Center



詠業科技股份有限公司  
Unictron Technologies Corporation  
Website: www.unictron.com

THIS DRAWINGS AND SPECIFICATIONS ARE THE PROPERTY OF UNICTRON TECHNOLOGIES CORPORATION AND SHALL NOT BE REPRODUCED OR USED AS THE BASIS FOR THE MANUFACTURE OR SALE OF APPARATUS OR DEVICES WITHOUT PERMISSION

Prepared by : Xenia

Designed by : Allen

Checked by : Mike

Approved by : Herbert

TITLE : 5.0 x 3.0 x 0.5 (mm) ISM 868MHz Ceramic Chip Antenna (AA701) Engineering Specification

DOCUMENT NO.

H2U64U1H2B0200

REV. I

## 5-2. Electrical Specifications (Evaluation Board Dimensions: 80 x 40 mm<sup>2</sup>)

### 5-2-1. Electrical Table

Characteristics		Specifications	Unit
Outline Dimensions		5.0 x 3.0 x 0.5	mm
Ground Plane Dimensions		80 x 40	mm
Working Frequency		863~870	MHz
VSWR (@ center frequency)*		2 Max.	
Characteristic Impedance		50	Ω
Polarization		Linear Polarization	
Peak Gain	(@868 MHz)	0 (typical)	dBi
Efficiency		47 (typical)	%

\*Center frequency means the frequency with the lowest value in return loss of the chip antenna on the evaluation board.

### 5-2-2. V.S.W.R. vs. Total Radiation Gain

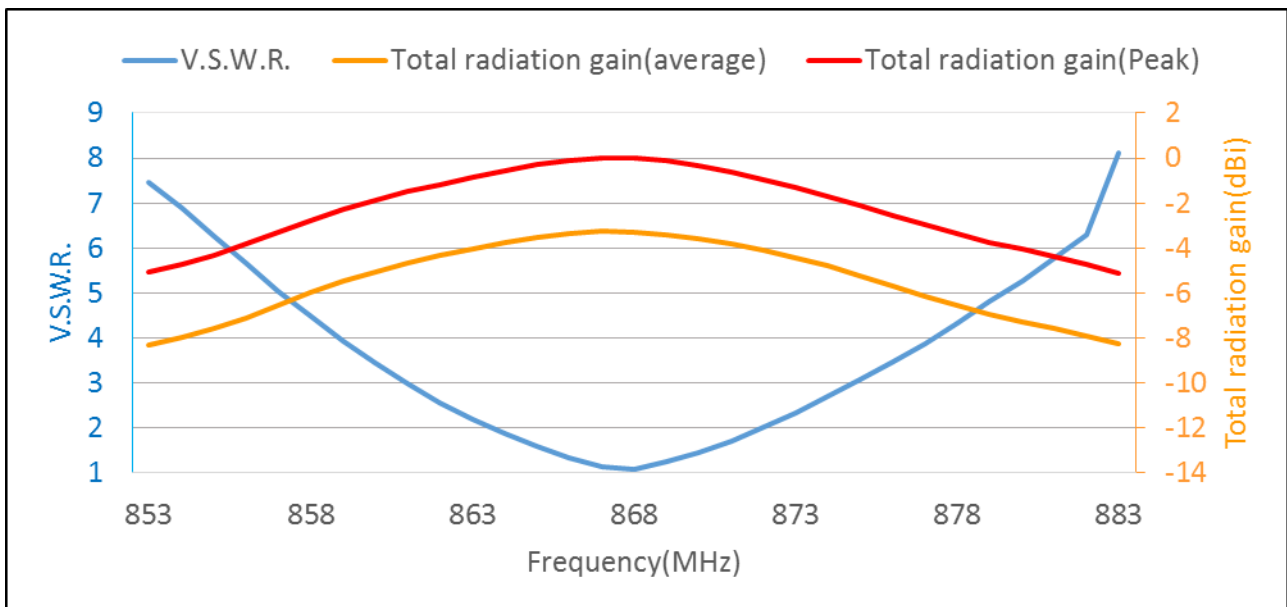

詠業科技股份有限公司  
Unictron Technologies Corporation  
Website: www.unictron.com

THIS DRAWINGS AND SPECIFICATIONS ARE THE PROPERTY OF UNICTRON TECHNOLOGIES CORPORATION AND SHALL NOT BE REPRODUCED OR USED AS THE BASIS FOR THE MANUFACTURE OR SALE OF APPARATUS OR DEVICES WITHOUT PERMISSION

Prepared by : Xenia

Designed by : Allen

Checked by : Mike

Approved by : Herbert

TITLE : 5.0 x 3.0 x 0.5 (mm) ISM 868MHz Ceramic Chip Antenna (AA701) Engineering Specification

DOCUMENT NO.

H2U64U1H2B0200

REV. I

## 6. Outline Dimensions of Antenna & Evaluation Board (unit: mm)

### 6-1. Antenna Dimensions

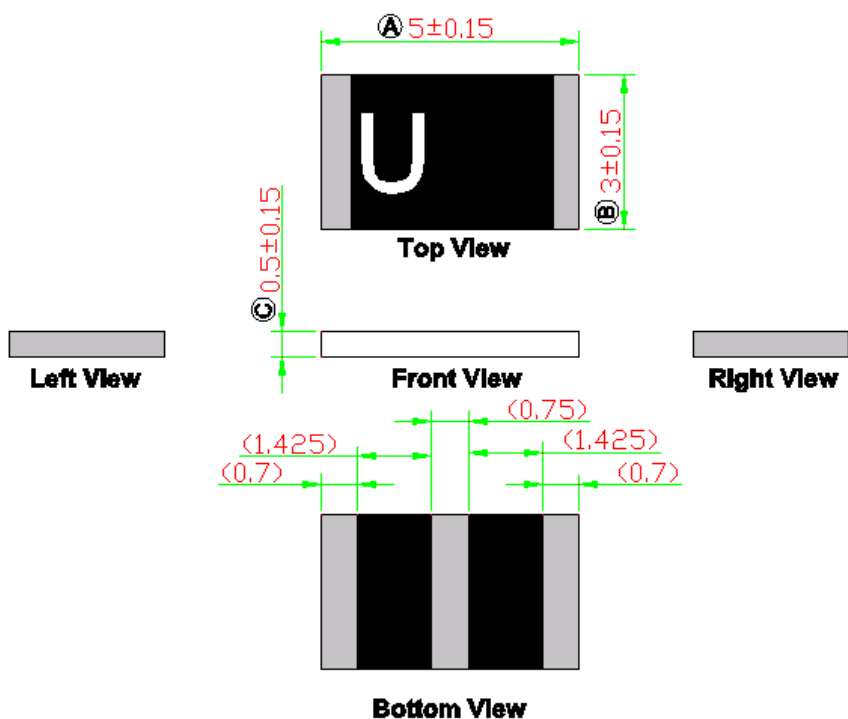

**NOTE:**

1. All materials are RoHS compliant.
2. "A~C" Critical Dimensions.
3. "( )" Reference Dimensions.

### PIN Definitions

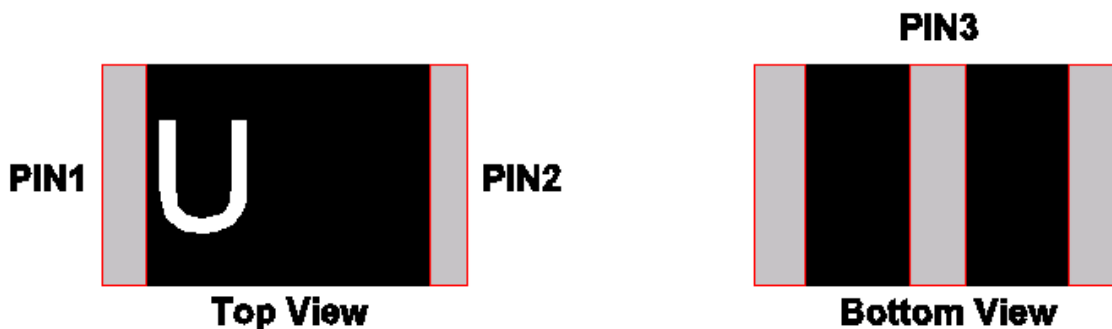

PIN	1	2	3
Soldering Pad	Signal	Tuning / Ground	Unictron Technologies Corp N/C 2016-12-28



詠業科技股份有限公司  
Unictron Technologies Corporation  
Website: www.unictron.com

THIS DRAWINGS AND SPECIFICATIONS ARE THE PROPERTY OF UNICTRON TECHNOLOGIES CORPORATION AND SHALL NOT BE REPRODUCED OR USED AS THE BASIS FOR THE MANUFACTURE OR SALE OF APPARATUS OR DEVICES WITHOUT PERMISSION

Prepared by : Xenia

Designed by : Allen

Checked by : Mike

Approved by : Herbert

TITLE : 5.0 x 3.0 x 0.5 (mm) ISM 868MHz Ceramic Chip Antenna (AA701) Engineering Specification

DOCUMENT NO.

H2U64U1H2B0200

REV. I

6-2. Evaluation Board with Antenna

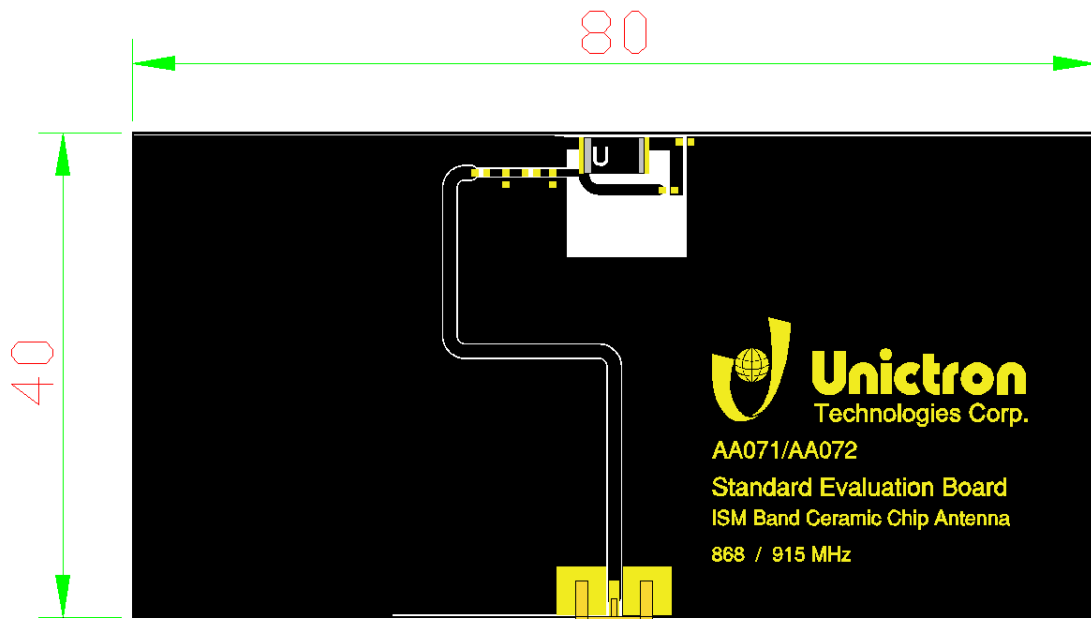

SMA female  
1/4"-36UNS-2A

unit: mm



詠業科技股份有限公司  
Unictron Technologies Corporation  
Website:www.unictron.com

THIS DRAWINGS AND SPECIFICATIONS ARE THE PROPERTY OF UNICTRON TECHNOLOGIES CORPORATION AND SHALL NOT BE REPRODUCED OR USED AS THE BASIS FOR THE MANUFACTURE OR SALE OF APPARATUS OR DEVICES WITHOUT PERMISSION

Prepared by : Xenia

Designed by : Allen

Checked by : Mike

Approved by : Herbert

TITLE : 5.0 x 3.0 x 0.5 (mm) ISM 868MHz Ceramic Chip Antenna (AA701) Engineering Specification

DOCUMENT NO.

H2U64U1H2B0200

REV.

I

## 7. Radiation Pattern (with 80 x 40 mm<sup>2</sup> Evaluation Board)

### 7-1. 3D Gain Pattern @ 868 MHz (unit: dBi)

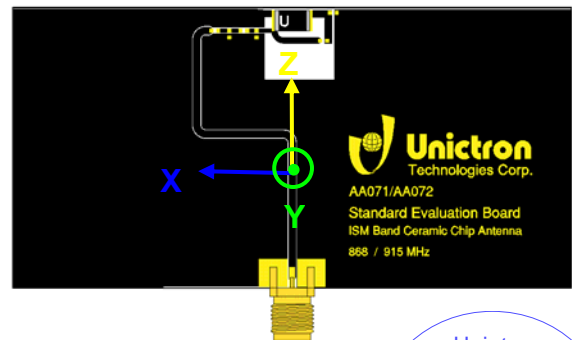
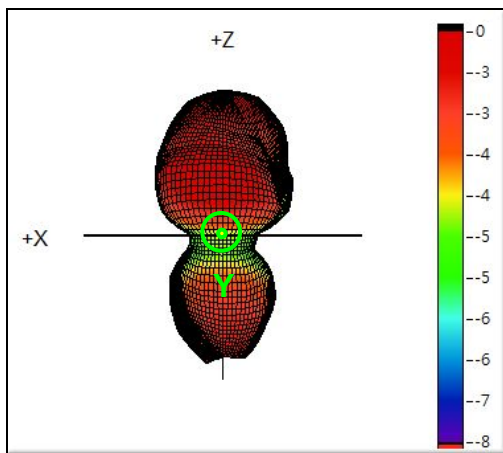
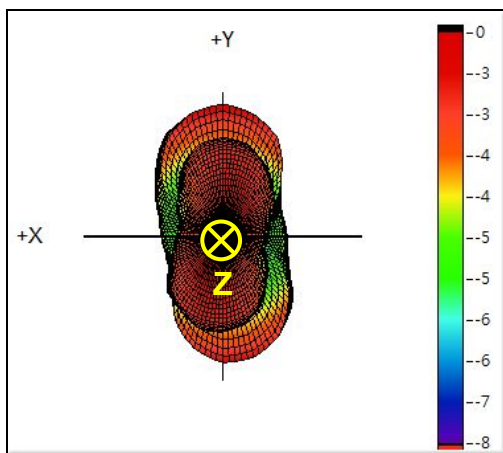
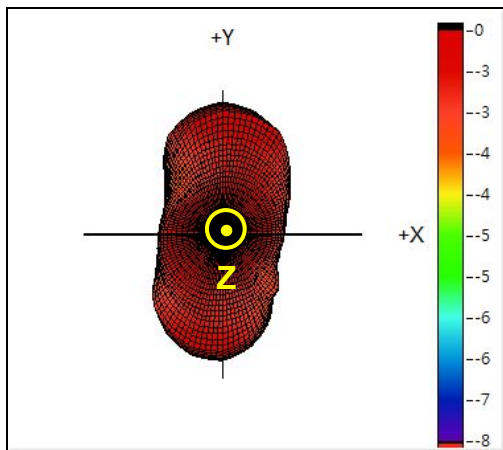

Unictron  
Technologies Corp.  
2016-12-28  
Document  
Control Center



詠業科技股份有限公司  
Unictron Technologies Corporation  
Website: www.unictron.com

THIS DRAWINGS AND SPECIFICATIONS ARE THE PROPERTY OF UNICTRON TECHNOLOGIES CORPORATION AND SHALL NOT BE REPRODUCED OR USED AS THE BASIS FOR THE MANUFACTURE OR SALE OF APPARATUS OR DEVICES WITHOUT PERMISSION

Prepared by : Xenia

Designed by : Allen

Checked by : Mike

Approved by : Herbert

TITLE : 5.0 x 3.0 x 0.5 (mm) ISM 868MHz Ceramic Chip Antenna (AA701) Engineering Specification

DOCUMENT NO.

H2U64U1H2B0200

REV.

I

## 8. Frequency Tuning and Matching Circuit

### 8-1. Chip antenna tuning scenario :

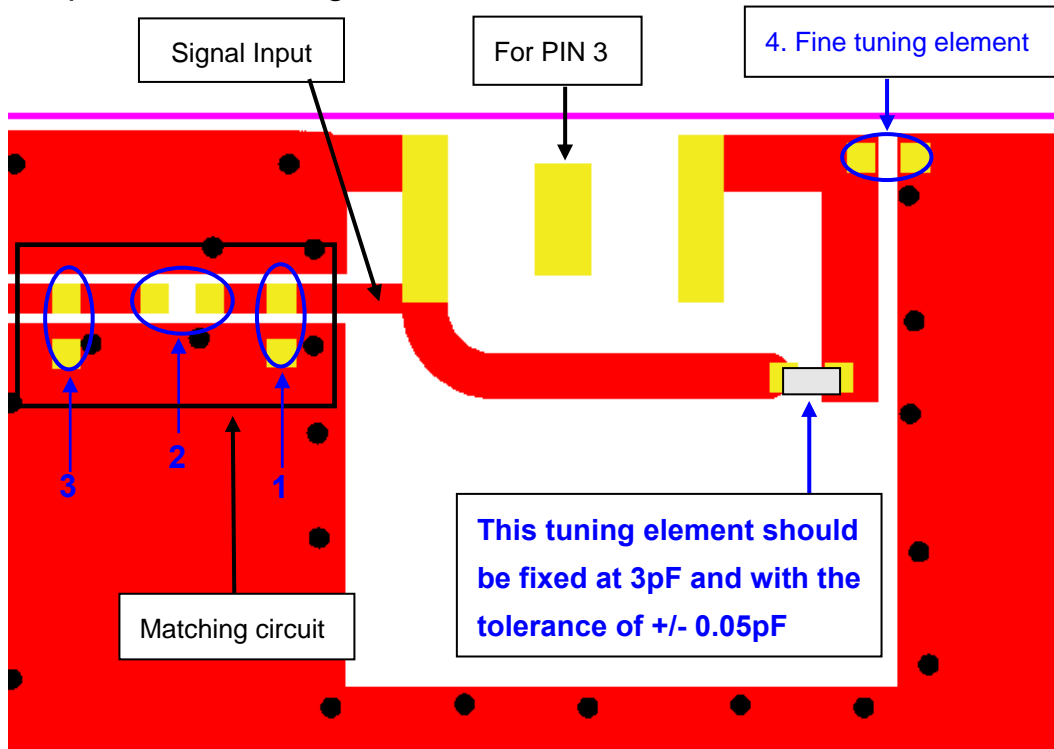

### 8-2. Matching circuit :

With the following recommended values of matching and tuning components, the center frequencies will be about 868 MHz at our standard 80x40 mm<sup>2</sup> evaluation board. However, these are typical reference values which may need to be changed when circuit boards or part vendors are different.

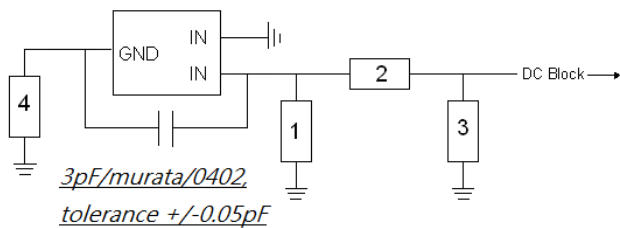

System Matching Circuit Component			
Location	Description	Vendor	Tolerance
1	N/A	-	-
2	2.7nH, (0402)	Murata	±0.1nH
3	N/A	-	-
4	Fine tuning element	Murata	±0.05pF

Unictron  
Technologies Corp.  
2016-12-28  
Document  
Control Center



詠業科技股份有限公司  
Unictron Technologies Corporation  
Website: www.unictron.com

THIS DRAWINGS AND SPECIFICATIONS ARE THE PROPERTY OF UNICTRON TECHNOLOGIES CORPORATION AND SHALL NOT BE REPRODUCED OR USED AS THE BASIS FOR THE MANUFACTURE OR SALE OF APPARATUS OR DEVICES WITHOUT PERMISSION

Prepared by : Xenia

Designed by : Allen

Checked by : Mike

Approved by : Herbert

TITLE : 5.0 x 3.0 x 0.5 (mm) ISM 868MHz Ceramic Chip Antenna (AA701) Engineering Specification

DOCUMENT NO.

H2U64U1H2B0200

REV.  
I

### 8-3. Reference for use of the frequency tuning element

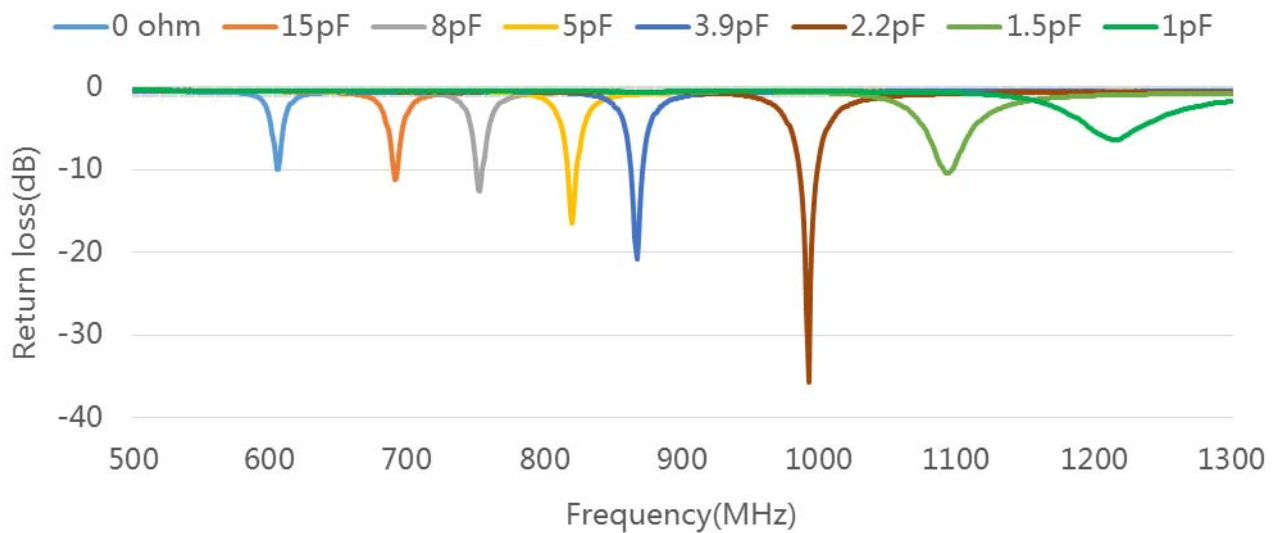
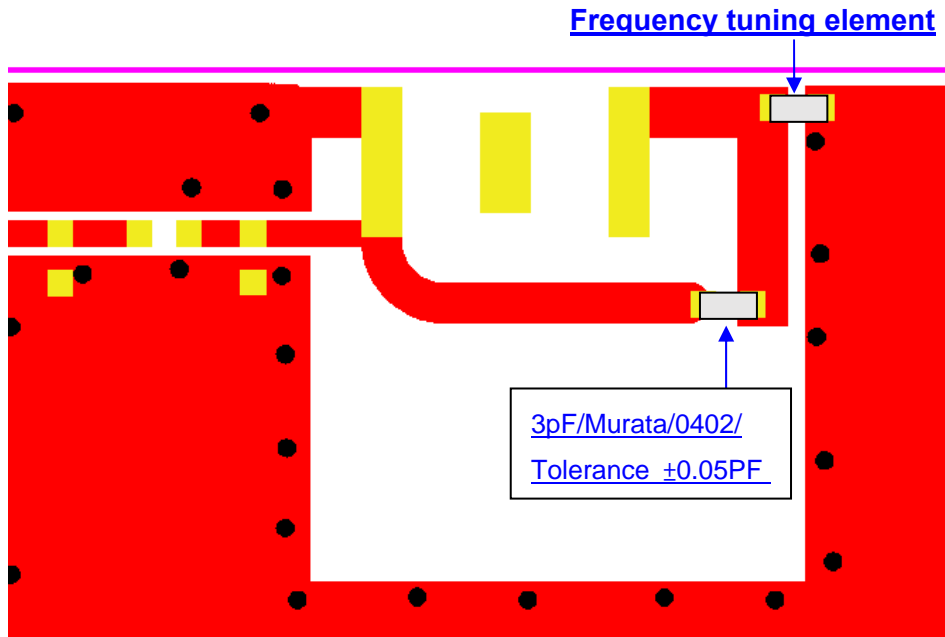

Unictron  
Technologies Corp.  
**2016-12-28**  
Document  
Control Center



詠業科技股份有限公司  
Unictron Technologies Corporation  
Website: www.unictron.com

THIS DRAWINGS AND SPECIFICATIONS ARE THE PROPERTY OF UNICTRON TECHNOLOGIES CORPORATION AND SHALL NOT BE REPRODUCED OR USED AS THE BASIS FOR THE MANUFACTURE OR SALE OF APPARATUS OR DEVICES WITHOUT PERMISSION

Prepared by : **Xenia**

Designed by : **Allen**

Checked by : **Mike**

Approved by : **Herbert**

**TITLE : 5.0 x 3.0 x 0.5 (mm) ISM 868MHz Ceramic Chip Antenna (AA701) Engineering Specification**

**DOCUMENT NO.**

**H2U64U1H2B0200**

**REV. I**



## 9. Soldering Conditions

### 9-1. Typical Soldering Profile for Lead-free Process

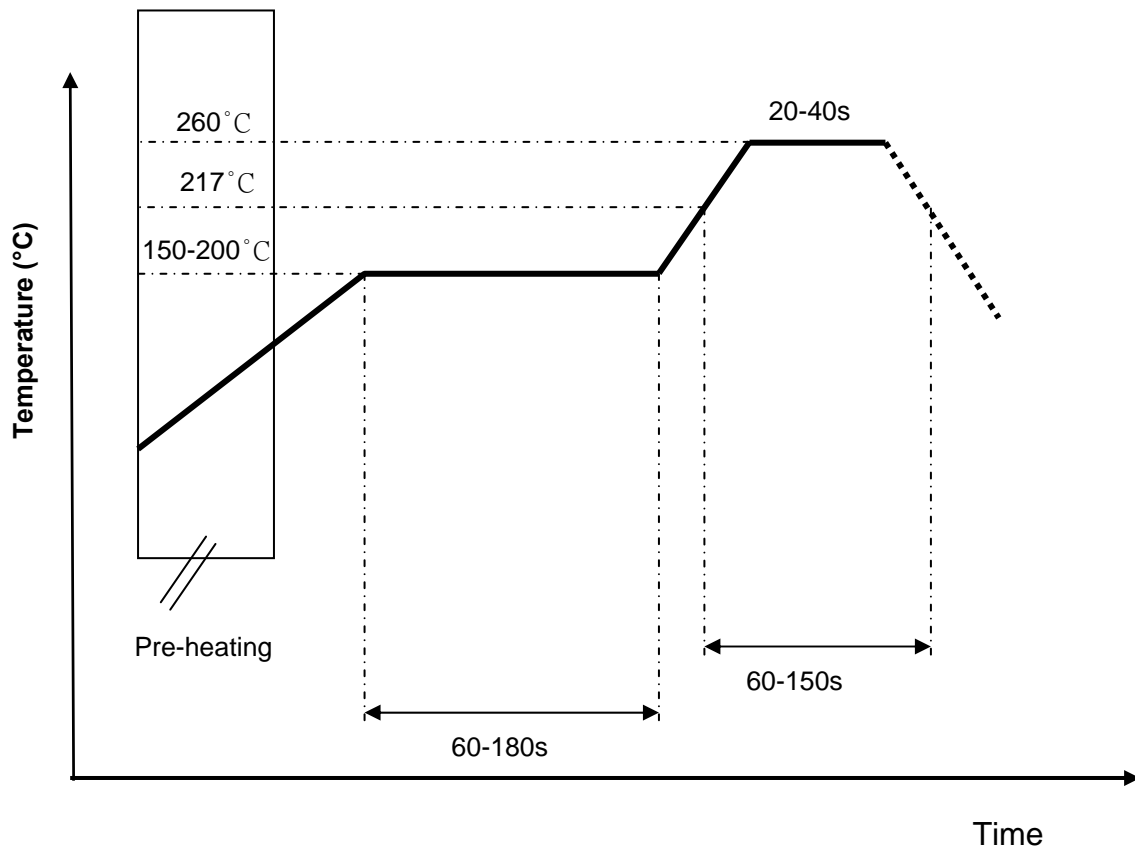

## 10. Reminders for users of Unictron's AA701 ceramic chip antennas

- 10-1. This chip antenna is made of ceramic materials which is relatively more rigid and brittle compared to circuit board materials. Furthermore, the length of this antenna is quite long. Bending of circuit board at the locations where chip antenna is mounted may cause the cracking of solder joints or antenna itself.
- 10-2. Punching/cutting of the break-off tab of PCB panel may cause severe bending of the circuit board which may result in cracking of solder joints or chip antenna itself. Therefore break-off tab shall be located away from the installation site of chip antenna.
- 10-3. Be cautious when ultrasonic welding process needs to be used near the locations where chip antennas are installed. Strong ultrasonic vibration may cause the cracking of chip antenna solder joints.



詠業科技股份有限公司  
Unictron Technologies Corporation  
Website: www.unictron.com

THIS DRAWINGS AND SPECIFICATIONS ARE THE PROPERTY OF UNICTRON TECHNOLOGIES CORPORATION AND SHALL NOT BE REPRODUCED OR USED AS THE BASIS FOR THE MANUFACTURE OR SALE OF APPARATUS OR DEVICES WITHOUT PERMISSION

Prepared by : Xenia

Designed by : Allen

Checked by : Mike

Approved by : Herbert

TITLE : 5.0 x 3.0 x 0.5 (mm) ISM 868MHz Ceramic Chip Antenna (AA701) Engineering Specification

DOCUMENT NO.

H2U64U1H2B0200

REV.

I

## 11. Packing

- (1) Quantity/Reel: 6000 pcs/Reel
- (2) Plastic tape:

a. Tape Drawing

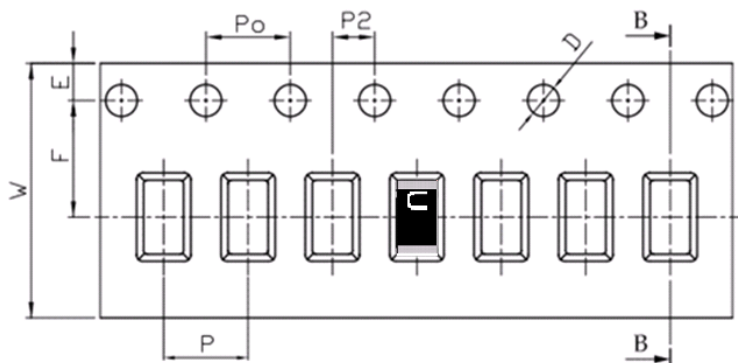

b. Tape Dimensions (unit: mm)

Feature	Specifications	Tolerances
W	12.00	±0.30
P	8.00	±0.10
E	1.75	±0.10
F	5.50	±0.10
P2	2.00	±0.10
D	1.20	+0.10 -0.00
Po	4.00	±0.10
10Po	40.00	±0.20

## 12. Operating & Storage Conditions

### 12-1. Operating

- (1) Maximum Input Power: 2 W
- (2) Operating Temperature: -40°C to 85°C

### 12-2. Storage

- (1) Storage Temperature: -5°C to 40°C
- (2) Relative Humidity: 20% to 70%
- (3) Shelf Life: 1 year

## 13. Notice

- (1) Installation Guide:

Please refer to Unictron's application note "General guidelines for the installation of Unictron's chip antennas" for further information.

- (2) All specifications are subject to change without notice.



詠業科技股份有限公司  
Unictron Technologies Corporation  
Website: www.unictron.com

THIS DRAWINGS AND SPECIFICATIONS ARE THE PROPERTY OF UNICTRON TECHNOLOGIES CORPORATION AND SHALL NOT BE REPRODUCED OR USED AS THE BASIS FOR THE MANUFACTURE OR SALE OF APPARATUS OR DEVICES WITHOUT PERMISSION

Prepared by : Xenia

Designed by : Allen

Checked by : Mike

Approved by : Herbert

TITLE : 5.0 x 3.0 x 0.5 (mm) ISM 868MHz Ceramic Chip Antenna (AA701) Engineering Specification

DOCUMENT NO.

H2U64U1H2B0200

REV.

I